

MADE  
IN  
GERMANY

# H6

## COMBIVERT H6



**Multi Axis Drives**





Karl-Ernst Brinkmann started his own success story with six employees.

Based on continuous growth, KEB has expanded into a medium sized company with 1,200 employees. We have remained an owner-managed company in its second generation, which is a source of pride for us. Structured growth for 40 years, a strong connection to our home base Barntrup and the East Westphalia-Lippe (OWL) economic region: Reliability creates trust - also in our role as an employer. Long-time employees impressively document the close connections to the company, our suppliers, partners and customers.

For 40 years Karl-Ernst Brinkmann and its staff has developed mechanical and electronic power transmission products. The long experience gained working in collaboration with our customers has now been reflected in controls.

We are in good shape for the future. As a result, our nine subsidiaries and production sites in the world markets of Europe, North America and Asia work with centralized data management and state-of-the-art development environments for hardware and software design. This is not the end of the story; it's just the beginning!

Content	page
Karl E. Brinkmann GmbH: KEB	2
Automation and drives	3
H6 Solution	4
H6 Mechanical system	5
H6 Cooling	6
EtherCAT System bus	7
H6 IEC control	8
H6 Supply unit 24 V DC	9
H6 Power supply	10
Mains chokes and EMC filters	11
H6 Sinusoidal supply and regen	12
AFE filters	13
H6 Single and double axis modules	14
H6 Motor feedback	16
H6 Integrated safety	17
Engineering tools	18
Remote I/O system	19
Automation	20
COMBICONTROL IPC controls	21
Servo motors	22
Geared motors	23
Addresses	24

From more than 30 years of experience with electronic drive technology, sophisticated control algorithms for all common motor versions have been developed. Based on our extensive experience on single inverter and servo drives, we are now pleased to offer the KEB COMBIVERT H6, the complete drive solution for machine automation.

KEB COMBIVERT H6 has integrated all the experiences in one device with new control and communication technology, perfect adaptable to machine builder requirements.

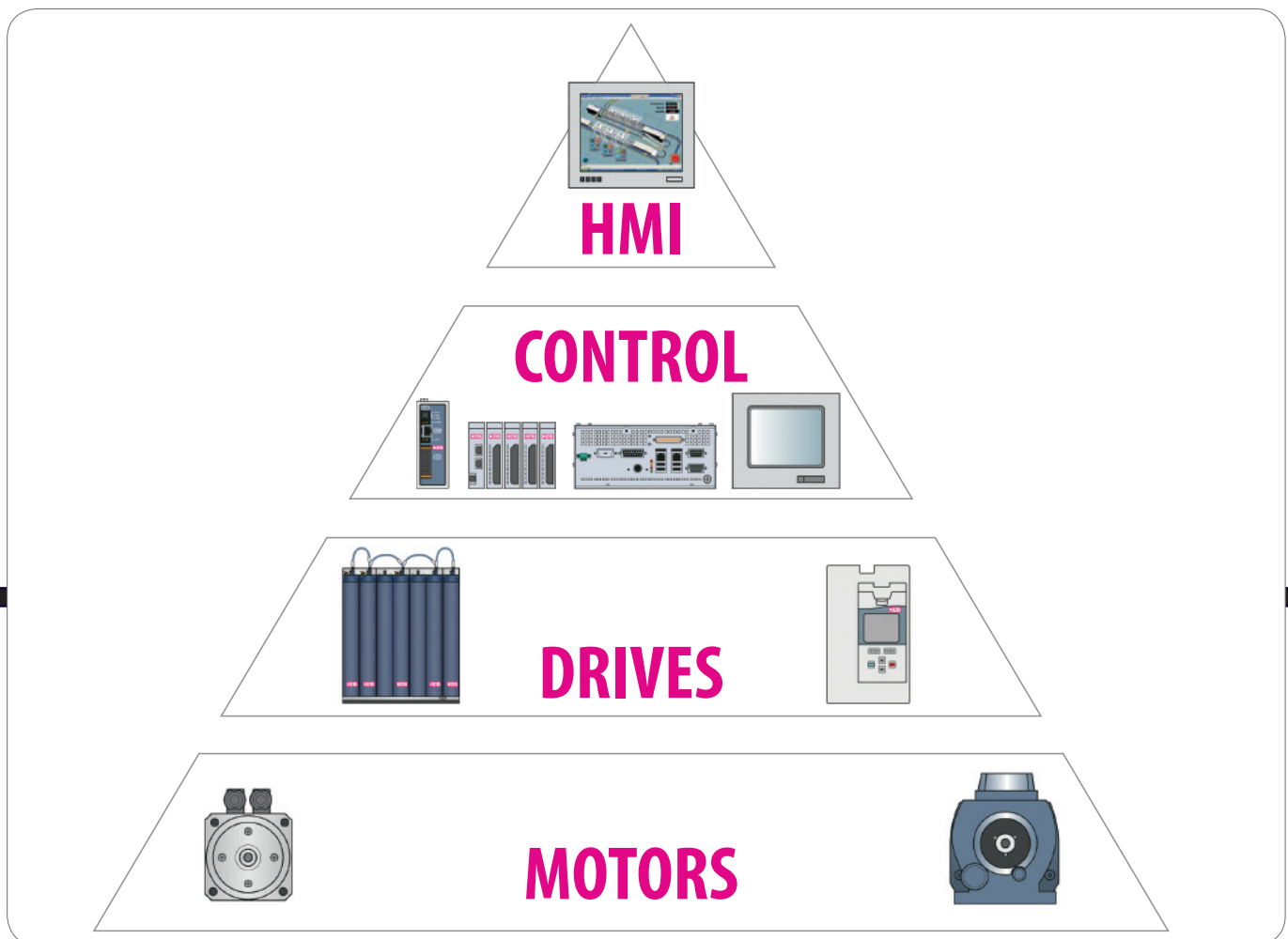

## The modular drive technology: KEB COMBIVERT H6

KEB COMBIVERT H6 is the new product family for multi-axis solutions with the following modular components:

- power supply
- active front end - power supply and regeneration
- single-axis drive units
- double-axis drive units
- 24 V DC-supply unit
- embedded IEC 61131-3 control unit
- fieldbus adaptation
- multi-encoder-interface
- 24 V brake control
- integrated safety system

## Features and benefits at a glance:

- space-saving design of a multi-axis drive system
- load share via protected DC bus link
- significantly reduced wiring and installation
- integrated Soft-PLC, Motion- and NC- control
- integrated 24 V DC supply
- standardised connection technology simplifies handling
- integrated two-level safety systems
- innovative central cooling solutions for heat dissipation outside the control cabinet
- improved quality and lifetime by means of active DC-bus capacitor cooling
- central operation concept for the complete system
- standardized programming tools with diagnostics

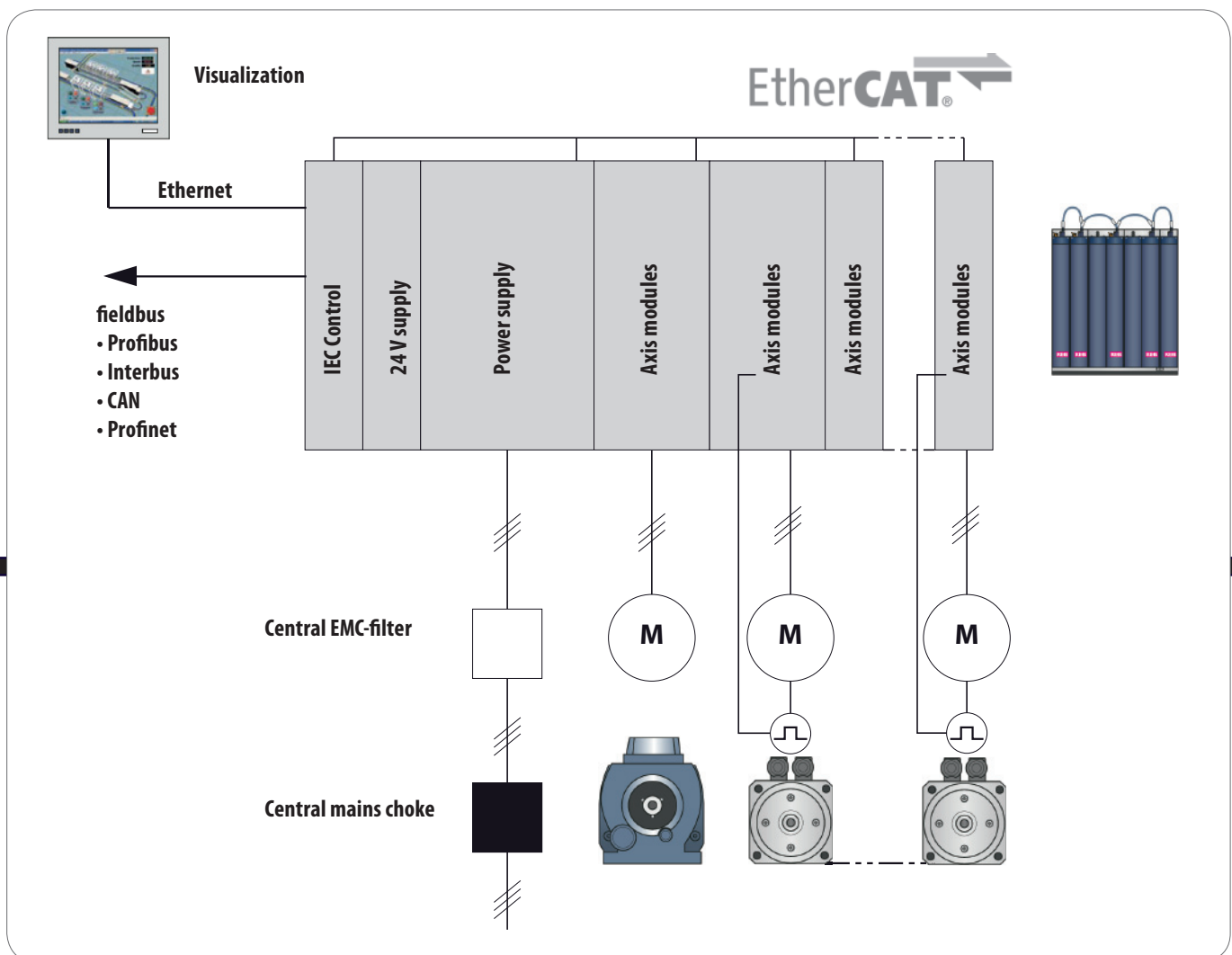

The integrated Embedded IEC 61131-3 control unit can be used as PLC (**BASIC**) **B**, Motion Control (**PRO**) **P** and NC Control (**ADVANCED**) **A** for the coordination of linked motions in machines and systems.

The integrated Ethernet interface connects with the host control level and the EtherCAT fieldbus master carries out the complete communication between the axes, sensors and devices in realtime.

In addition peripheral IPC-based BOX-PC or PANEL-PC are available with integrated touchscreen monitor in various performance classes and realtime capable Windows XP embedded operation system.



**Control-supply unit**  
IEC control with 24 V DC supply  
**Supply Module**  
central 24 V DC supply

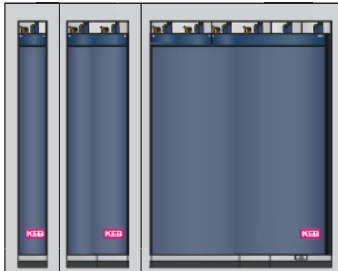

**Central power supply B6-rectifier**

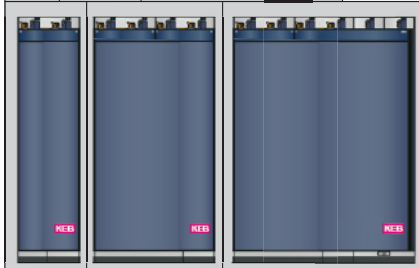

**AFE active-front-end  
power supply and regen operation**

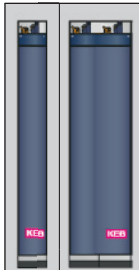

**Double-axis  
drive modules**

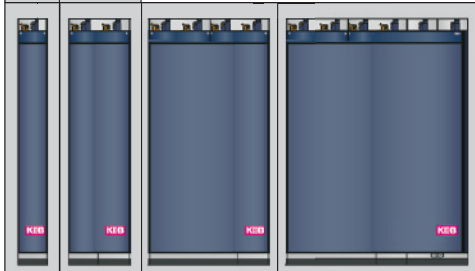

**Single-axis  
drive modules**

50    100    200    300

■ mounting dimensions for all module sizes:

Wide	50 / 100 / 200 / 300 mm
Height	407 mm
Depth - Flat rear	198 mm
Depth - Air cooled	295 mm

## Air cooled or Flat rear

Depending on the installation requirements the KEB COMBIVERT H6 system is available for two heat-exchange solutions:

- Integrated air cooled design with forced ventilation
- Central heat-exchange Flat rear modules in combination with central heat sinks for aircooled or liquid cooled plates.

The mechanical construction is based on basic units with Flat rear heat plates. Its central heat sink supports the direct transfer of the main power losses inside and outside of the control cabinet. Due to the standard mounting pattern with 50 mm hole distance, central heat sink of different widths are prepared for direct installation of the modules.

For best possible heat dissipation, we recommend push through heatsinks. Technical details and accessories are available.

Further customized versions are available on request.

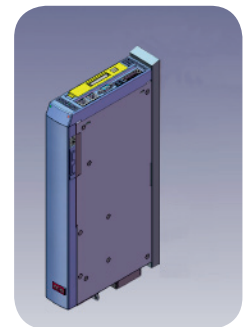
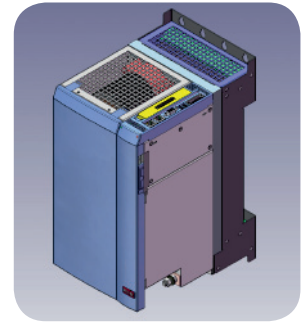

## Central cooling plates

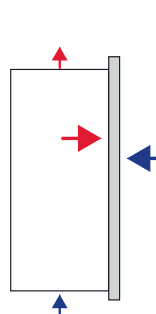
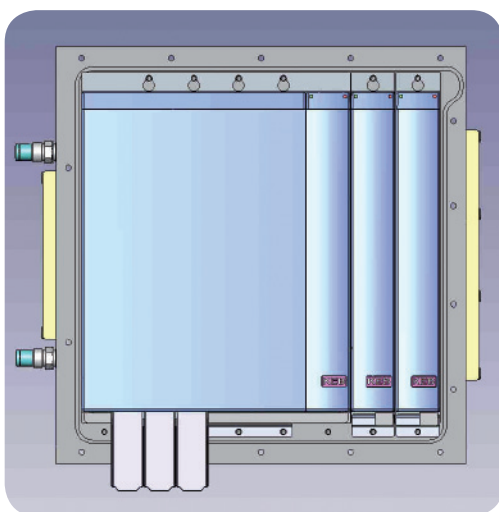

Flat rear

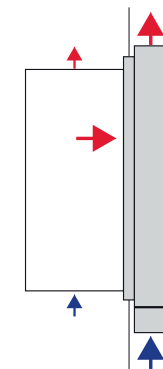

Push through heat sink

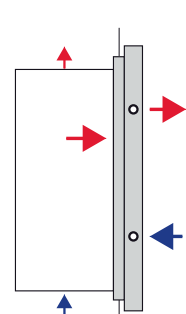

Liquid cooling



## Fast Ethernet communication

High speed bus allows precise control of multiple axes.  
 Isochronous control of up to 8 axes in cycle time of less than 250  $\mu$ s.



The KEB EtherCAT system bus offers the following advantages:

- standardised
- different master controls are available
- high speed (100 Mbit/s)
- unlimited number of nodes
- CAN over EtherCat protocol
- high market acceptance and presence
- direct integration of external KEB Remote I/O's or other devices



Typical controller data	single axis	double axis
Current controller cycle	125 $\mu$ s	250 $\mu$ s
Speed controller cycle	250 $\mu$ s	500 $\mu$ s
Standard cycle	250 $\mu$ s	500 $\mu$ s
Digital I/O cycle	250 $\mu$ s	250 $\mu$ s
Fast input cycle	100 $\mu$ s	100 $\mu$ s

Module width	Central <b>water cooler</b> part number	W [mm]	H [mm]	D [mm]	m [kg]
400 mm	04.H6.TFW-0400	486	457	32	21
600 mm	06.H6.TFW-0600	686	457	32	29
800 mm	08.H6.TFW-0800	886	457	32	37
1,000 mm	10.H6.TFW-1000	1,086	457	32	45
1,200 mm	12.H6.TFW-1200	1,286	457	32	53

Module width	Central <b>air cooler</b> part number push through	W/W1 [mm]	H/H1 [mm]	D/D1 [mm]	m/m1 [kg]
400 mm	04.H6.TFA/TFB-0400	450/486	540/572	122/124	29.6/30.3
600 mm	06.H6.TFA/TFB-0600	654/683	540/572	122/124	42.8/43.3
800 mm	08.H6.TFA/TFB-0800	846/886	540/572	122/124	56/56.8
1,000 mm	10.H6.TFA/TFB-1000	1,050/1,086	540/572	122/124	69/69.9

part number TFB - for inside mounting with data W1/HV/D1/m1

H6- Control unit

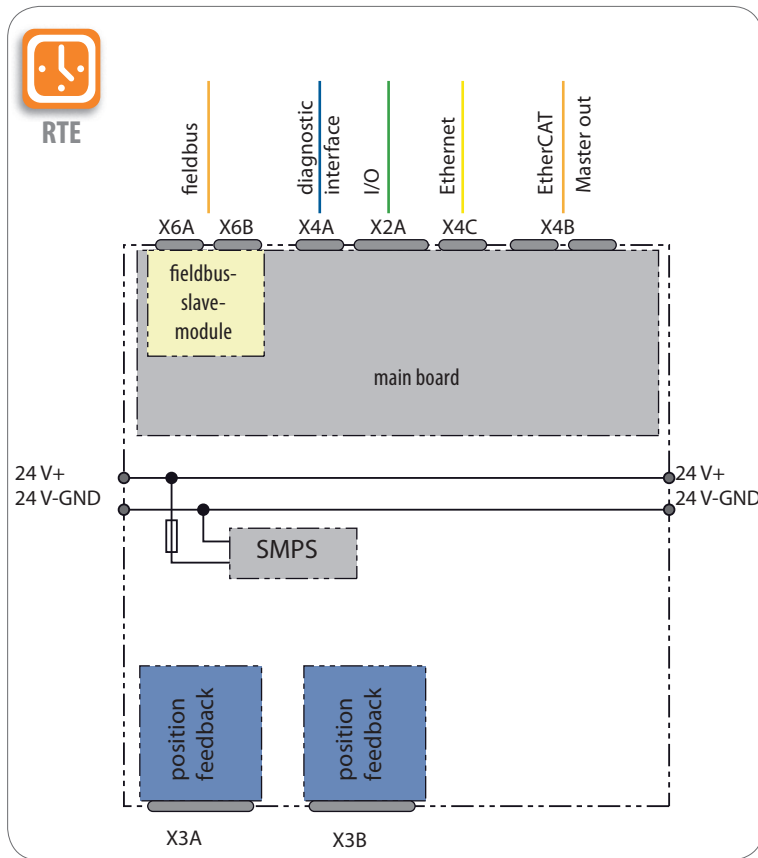

Embedded Controls with the high-performance CPU's (32bit RISC / 200MHz / FPU). They are programmable in IEC 61131-3, include an EtherCAT fieldbus master for applications with PLC, Motion Control and NC-functionality.

The Ethernet interface and the local RS232/485 interface provides universal connectivity for host controls, user menu / HMI and external sensors or devices. Connection to higher fieldbus layers is carried out by means of pluggable fieldbus cards. Currently Profibus, CAN, Interbus and soon Profinet are supported.

Furthermore two optional sockets for the two channel Multi encoder system integrate more position feedback devices into the automation system.



CONTROL SUPPLY UNIT

The 50 mm CONTROL SUPPLY UNIT is the highly efficient solution for PLC, Motion Control and integrated 24 V DC supply - containing the 24 V supply module and the Embedded Control, guarantees a further size reduction of the control cabinet.

CONTROL SUPPLY UNIT	Control unit / 24 V DC-supply unit with EtherCAT Master	
Part number	0_.H6.GAB-11_0	0_.H6.GDB-11_0
Floating Point Unit	-	■
Internal Memory	3 MB	256 MB
Systembus EtherCAT, 2 x RJ45 [MB]	10/100	
Diagnostic interface , D-Sub 9	RS 232/485	
Power supply U <sub>n</sub> [V <sub>DC</sub> ]	24	
Digital IN	4	
Digital OUT	4	
Encoder input optional with 2 channels	Multi-Interface for Resolver, BISS, EnDat, Hiperface, Incremental, SinCos	
Module size W x H x D [mm]	50 x 407 x 198 / 295*	
Air cooled housing*	■	
Flat rear housing	■	



### 24 V DC supply module

The central control voltage supply unit generates constant 24 V DC for the internal power supply of the axis modules.

The double feed from the DC bus and, additionally from the 1/3-phase mains input ensures an uninterruptable operation of the control voltage and bus communication even with disconnected power units. In addition, a controlled deceleration at the drive axis is ensured when the mains supply is down.

Besides the digital outputs, the maximum current of 25 A can usually directly supply several permanent magnet or spring applied brakes of the connected motors. Certainly, the module can be integrated into the two-channel error bus.

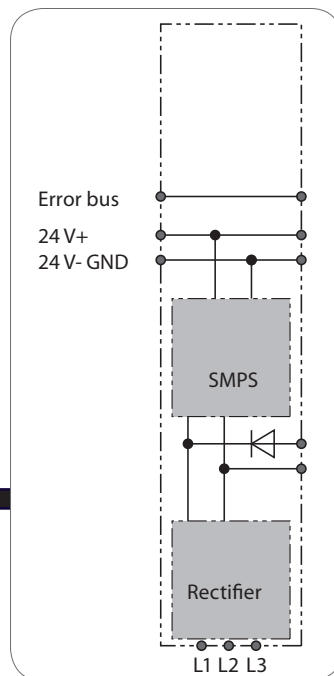

SUPPLY UNIT		24 V DC-supply unit 01.H6.GBB-11_0
Rated apparent output power $S_n$	[VA]	600
Rated active power $P_n$	[W]	500
Nominal input voltage	[V <sub>AC</sub> ]	180 ... 480
Rated output current $I_n$	[A <sub>DC</sub> ]	25
Maximum current $I_{max}$	[A <sub>DC</sub> ]	40
Power loss at nom. operation $P_L$	[W]	65
Module size W x H x D	[mm]	50 x 407 x 198 / 295*
Air cooled housing*		■
Flat rear housing		■

## Supply unit with B6 rectifier

The central supply unit with controlled rectifier provides power to the drive system via the DC-bus and buffers partly the regenerative energy in the DC-bus capacitors, which accounts for approx. 1/3 of the total system. The standard internal braking transistor (GTR7) gives the option to connect a braking resistor directly for dynamic braking. The internal two-channel error bus and the system bus fully integrate the units into the fieldbus and control system.

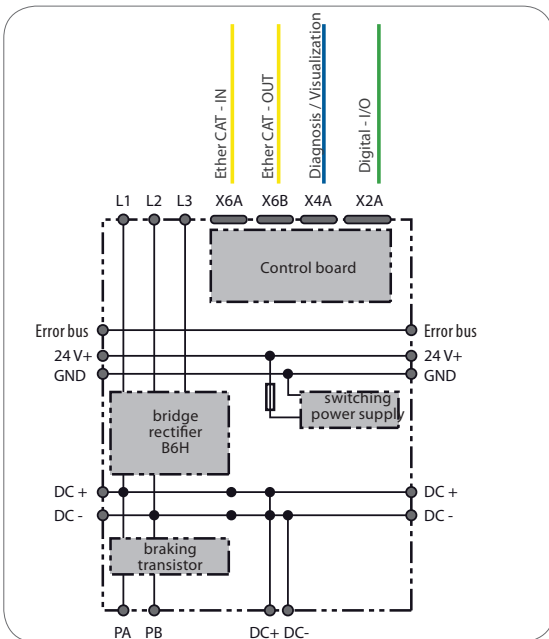

Power supply	size	15	18	19	20	21	24	25	27	28
Supply type		B6 bridge rectifier __.H6.C__								
Rated apparent output power $S_n$	[kVA]			31	39.5	51	104	131	170	242
Rated active power $P_n$	[kW]	11	22	30	37	48	95	120	155	225
Rated input voltage $U_n$	[V]	400								
Rated input current $I_n$	[A <sub>AC</sub> ]			45	57	74	150	190	245	350
Base load current $I_H$	[A <sub>AC</sub> ]			37	47	61	123	155	201	287
Current in S6 mode $I_{S6_{40\%/10min}}$	[A <sub>AC</sub> ]			58	74	96	195	246	319	455
Maximum current $I_{max}$	[A <sub>AC</sub> ]			81	103	133	270	341	441	630
OC-tripping current $I_{OC}$	[A <sub>DC</sub> ]			97	123	160	324	410	529	756
Rated output current $I_{DCn}$	[A <sub>DC</sub> ]			55	70	90	180	230	300	435
OH level temperature	[°C]	80	80	80	80	60	80	60	80	60
Power loss at nom. operation at heat sink $P_{Dext}$	[W]			175	250	320	375	450	650	950
Power loss at nom. operation inside $P_{Dint}$	[W]			60	75	85	60	70	85	1100
Module width	[mm]	50	50	100	100	100	300	300	300	300
Air cooled housing		in preparation		■	■	-	■	-	■	-
Flat rear housing		in preparation		■	■	■	■	■	■	■

Technical data for 2/4-pole motors; other number of poles or special motors: adapt supply module for DC-current. Mains choke with  $u_k = 4\%$  assumed.

## Mains chokes

The KEB COMBIVERT H6 uses a single choke from our standard Z1.B04 range on the input. This will give a  $u_k = 4\%$ . Size selection is related to the average input current and peak load characteristic of the multi axis system.

Mains choke	$I_n$	$I_{max}$	L	W	H	D	m
Part number	[A]	[A]	[mH]	[mm]	[mm]	[mm]	[kg]
14.Z1.B04-1000	17.3	29.7	1.7	148	77	145	2.8
15.Z1.B04-1000	25.2	36	1.16	178	87	180	4.4
16.Z1.B04-1000	34.7	52.1	0.847	178	100	178	5.9
17.Z1.B04-1000	44.1	66.2	0.667	219	115	215	8.4
18.Z1.B04-1000	52.5	78.8	0.560	219	120	220	10
19.Z1.B04-1000	63	94.5	0.467	219	135	220	12
20.Z1.B04-1000	79	118.5	0.372	219	150	220	12
21.Z1.B04-1000	95	142.5	0.310	267	155	207	15.6
24.Z1.B04-1000	189	283.5	0.156	316	225	235	24.8
25.Z1.B04-1000	221	331.5	0.133	316	225	235	25
27.Z1.B04-1000	315	472.5	0.093	352	230	265	34
28.Z1.B04-1000	390	585	0.075	388	245	295	41.5

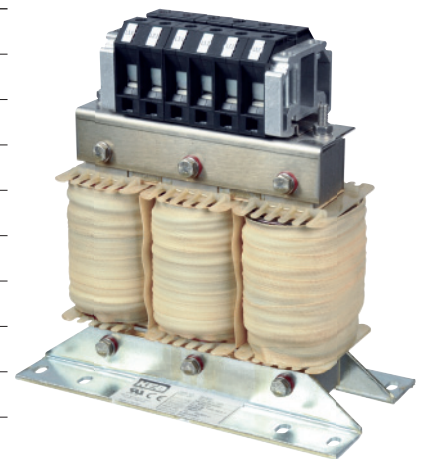

## Line filter

Compliance with the international standards for industrial and residential areas requires the use of EMC filters. In the **KEB COMBIVERT H6** modular system, they are installed centrally, above of the supply unit. The sizing of the modules according to EN 61800-3 environment C1 and C2 are typically based on 4 drive axes with a total motor cable length of 300 m.

Line filter	$I_n$	$I_{lk50}$	$I_{lkmax}$	$P_d$	W	H	D	m
Part number	[A]	[mA]	[mA]	[W]	[mm]	[mm]	[mm]	[kg]
14.E6.T60-3000	22	< 3	12	14	55	252	92	1.3
16.E6.T60-3000	43	< 3	31	18	65	252	106	1.8
18.E6.T60-3000	65	< 3	24	27	130	240	142	3.9
20.E6.T60-3000	100	< 3	81	54	160	240	142	5.0
22.E6.T60-3000	150	< 3	52	80	200	321	190	9.0
24.E6.T60-3000	200	< 3	117	100	200	321	190	9.2
27.E6.T60-3000	330	< 3.5	123	160	250	516	194	22.5
28.E4.T60-1001	410	< 3	220	50	260	390	115	18.5



## AFE supply units

The sinusoidal regeneration uses the AFE and charging unit in combination. This offers a technically advanced alternative to the standard rectifier power supply, ideal for solutions requiring high regenerative performance. The charging unit takes control of the power contactor after the DC bus is fully charged.

The boost converter of this power supply unit maintains the DC bus voltage on an adjustable level i.e. at 650 V DC, which can be used to optimize motor sizing. A brake transistor (GTR7) is integrated.

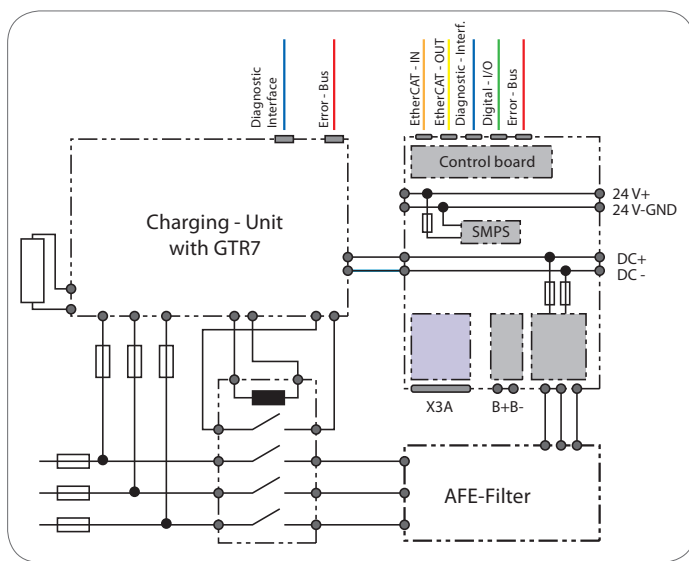

AFE-supply	size	14	19	21	24	26
Supply type		AFE-sinusoidal power supply / regeneration system __.H6.D__				
Rated apparent output power $S_n$	[kVA]	11	42	62	125	173
Rated active power $P_n$	[kW]	7.5	30	45	90	132
Rated input voltage $U_n$	[V]	400				
Rated input current $I_n$	[A <sub>AC</sub> ]	16.5	60	90	180	250
Maximum current $I_{max}$	[A <sub>AC</sub> ]	33	108	162	270	378
OC-tripping current $I_{OC}$	[A <sub>DC</sub> ]	39.6	130	194	324	450
Rated switching frequency $f_s$	[kHz]	8	8	8	8	4
OH level temperature	[°C]	80	80	80	80	80
Power loss at nom. operation at heat sink $P_{Dext}$	[W]	181	698	1,090	2,315	1,979
Power loss at nom. operation inside $P_{Dint}$	[W]	53	95	131	218	189
Module width	mm	100	200	200	300	300
Air cooled housing		■	■	■	■	■
Flat rear housing		■	■	■	■	■

## AFE filters

In applications with high or continuous regenerative power, the energy provider requires a low ratio of harmonics (THD value) at the power supply unit.

The AFE-supply / regenerative moduls of the KEB COMBIVERT H6 system have to be used with proper designed AFE-filters for sinusoidal regeneration operation. Depending on the application, these filters are designed for 100 % or 60 % regenerative duty cycle.

Accessories	AFE filter	$I_n$ 100 %	W	H	D	m
AFE supply unit	part number	[A]	[mm]	[mm]	[mm]	[kg]
14.H6.Dxx-xxxx	14.H6.J4E-1000	16.5	200	470	214	16.0
19.H6.Dxx-xxxx	19.H6.J4F-1000	60	250	570	214	30.0
21.H6.Dxx-xxxx	21.H6.J4F-1001	90	250	570	214	42.5
24.H6.Dxx-xxxx	24.H6.J4G-1000	180	300	750	271	65.0

Accessories	AFE filter	$I_n$ 60 %	W	H	D	m
AFE supply unit	part number	[A]	[mm]	[mm]	[mm]	[kg]
19.H6.Dxx-xxxx	19.H6.J4E-1000	60	200	470	214	21.5
21.H6.Dxx-xxxx	21.H6.J4F-1000	90	250	570	214	32.0
24.H6.Dxx-xxxx	24.H6.J4F-1000	180	250	570	214	41.0
26.H6.Dxx-xxxx	26.H6.J4G-1000	250	300	750	271	67.0

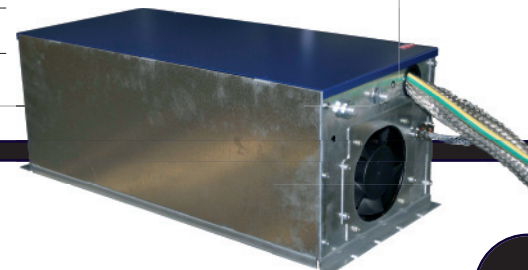

## Charging unit

The charging unit operates in combination with the AFE supply units for sinusoidal regen operation and contains the GTR7 brake transistor for the peak load transfer to external resistors.

Charging unit	part number	00.H6.FAB-1100
Rated input voltage $U_n$	[V]	400
Power loss at nom. operation inside $P_{Dint}$	[W]	5
Module size W x H x D	[mm]	50 x 407 x 198 / 295*
Braking transistor		
Max. braking power with c.d.f. 40 %	[kW]	33
Max. braking current $I_{max_{OC}}$	[A <sub>DC</sub> ]	146
Max. braking resistor	[Ohm]	6
Switching frequency $f_s$	[kHz]	4
Air cooled housing*		■
Flat rear housing		■

## Single-axis and double-axis drive units

- DC supply with internal fuses in both DC conductors
- External 24 V DC supply  
i.e. for the internal switching power supply unit and the direct DC supply of a 24 V motor brake
- Internal controlled voltage sources, independent from DC-bus voltage

## Drive units – control terminals

- **EtherCAT system bus**  
realtime data transfer offset- and actual values between IEC-controller and drive modules
- **Two-channel error bus**  
Channel-1: error output of the connected DC bus members  
Channel-2: charging status of the DC bus of the supply unit
- **Diagnose interface**  
RS232 / RS485- Interface to connect service tools and displays
- **Digital I/O**  
4 digital inputs (IEC 61131-1)  
4 digital outputs (High Side Driver, no relays, short circuit protected)

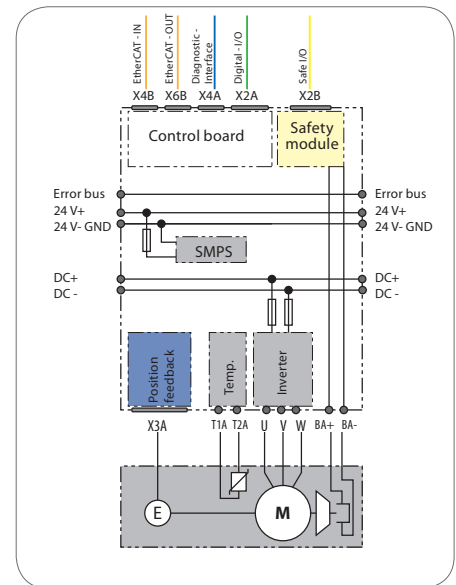

Axis modules	size	07	10	12	13	14	15	16	18	19
Version		Single-axis Module __.H6.A__								
Rated apparent output power $S_n$	[kVA]	1.8	4	6.2	8.3	11	17	23	33	42
Rated active power $P_n$	[kW]	0.75	2.2	4	5.5	7.5	11	15	22	30
Rated input voltage $U_n$	[V]	400								
Rated input current $I_n$	[A]	2.6	5.8	9	12	16.5	24	33	48	60
Maximum current $I_{max}$	[A]	5.2	11.6	18	24	33	43.2	59	86	90
OC-tripping current $I_{OC}$	[A]	6.2	13.9	21.6	28.8	39.6	51.8	71	103	135
Switching frequency $f_{s_{nom/max}}$	[kHz]	4/8 (with derating)								
OH level temperature	[°C]	80	80	80	80	80	80	80	80	80
Power loss at nom. operation at heat sink $P_{Dext}$	[W]	18	37	58	77	99	150	209	316	382
Power loss at nom. operation inside $P_{Dint}$	[W]	18	22	36	31	39	47	61	72	79
Module width	[mm]	50	50	50	100	100	100	100	100	100
Air cooled housing		■	■	■	■	■	■	■	■	■
Flat rear housing		■	■	■	■	■	■	■	■	■



## Drive units - software communication

- CiA402 - Cyclic synchronous position mode
- CiA402 - Cyclic synchronous velocity mode
- CiA402 - Cyclic synchronous torque mode

Implementation in accordance with ETG Implementation Guideline for CiA402 drive profiles

Driver for 3S – Softmotion and NC for KEB COMBIVERT H6 (based on Cyclic synchronous position mode)

## Motor control features

Operation of synchronous and asynchronous motors

- Sensorless control of synchronous motors (S.C.L.)
- Sensorless control of asynchronous motors (A.S.C.L.)
- Rotorposition detection by HFI (high frequencs injection) at standstill
- Field weakening for synchronous motors (enhanced functionality)
- High torque and speed accuracy with and without encoder system



20	21	22	23	24	25	07	10	12	13	14	15
						Double-axis Module __.H6.B__					
52	62	76	100	125	145	2 x 1.8	2 x 4	2 x 6.2	2 x 8.3	2 x 11	2 x 17
37	45	55	75	90	110	2 x 0.75	2 x 2.2	2 x 4	2 x 5.5	2 x 7.5	2 x 11
						400					
75	90	110	145	180	210	2 x 2.6	2 x 5.8	2 x 9	2 x 12	2 x 16.5	2 x 24
135	162	198	218	270	315	2 x 5.2	2 x 11.6	2 x 18			
162	194	238	261	324	378	2 x 6.2	2 x 13.9	2 x 21.6			
						4/8 (with derating)					
80	80	80	80	80	80	80	80	80	80	80	80
522	641	802	1,117	1,341	1,656	36	74	116			
85	89	119	165	149	165	26	34	42			
200	200	200	200	300	300	50	50	50	100	100	100
■	■	■	-	■	■	■	■	■	in preparation		
■	■	■	■	■	■	■	■	■	in preparation		

## Multi encoder system

Various motor designs and application requirements define the type of encoder system.

This fixes the type of encoder feedback inside of drives.

To increase flexibility KEB COMBIVERT H6 has integrated these requirements in one hardware solution, simply adjustable via software.

The Multi encoder interface provides two channels, selectable for the following feedback types

- Resolver
- Incremental TTL
- BISS
- SSI
- SinCos
- Endat 2.1
- Endat 2.2
- Hiperface

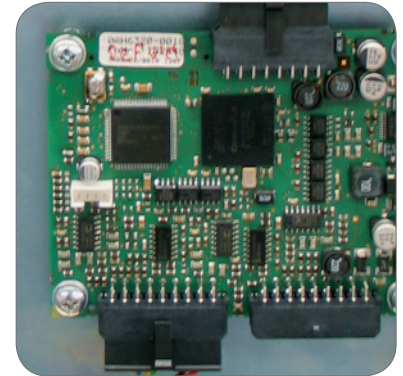

In addition to the installation inside of the drive axis the feedback card could be used inside of the KEB COMBIVERT H6 control unit to extend the inputs for externally placed encoder systems.

## Projected safety functions in KEB COMBIVERT H6, DIN IEC 61800-5-2

Short sign	Short description	Standard	Module 1	Level IEC 61508	Level ISO 13849	Module 2	Inputs	Safe encoder
STO	Safe Torque Off	--	X	SIL 3	PL e	X	STO	--
SBC	Safe Brake Control	--	X	SIL 3	PL e	X	SBC	--
SS1	Safe Stop 1	--	--	SIL 3	PL e	(x)	Function 1/2	●
SS2	Safe Stop 2	--	--	SIL 3	PL e	(x)	Function 1/2	●
SOS	Safe Operating Stop	--	--	SIL 3	PL e	(x)	Function 1/2	●
SLS	Safely Limited Speed	--	--	SIL 3	PL e	(x)	Function 1/2	●
SLP	Safe Limited Position	--	--	SIL 3	PL e	(x)	Function 1/2	●
SLI	Safe Limited Increment	--	--	SIL 3	PL e	(x)	Function 1/2	●
SDI	Safe Direction	--	--	SIL 3	PL e	(x)	Function 1/2	●
SSM	Safe Defined Max. Speed	--	--	SIL 3	PL e	(x)	Function 1/2	●
Safe Programming Safe Grid		--	--	Basis		COMBIVIS 6 / COMBIVIS studio 6		

**Drive modules with integrated safety systems**

Depending on the application the design of safety related equipment demands different concepts, which are more and more supported by drive based safety functions. The axis modules of the KEB COMBIVERT H6 series can be equipped with scaleable safety functions:

- **Standard**

non safety plug-in module for controller enable, brake release and 24 V output / 100 mA

- **Safety-type 1**

Plug-in module 1 for **single and double axis drive units** with safe shutdown of the drivers power supply operated only by hardware. The certification of the functions Safe Torque Off (STO) and Safe Brake Control (SBC) will be according to ISO 13849, Performance-Level e / IEC 62061, SIL3.

- **Safety-type 2**

Plug-in module 2 for **single axis drive units** with safe inputs and safe shutdown operated via redundant micro-controller configuration, provided with the main functions, e.g. safety type 1 and two additional selectable functions according table page 16 - module 2.

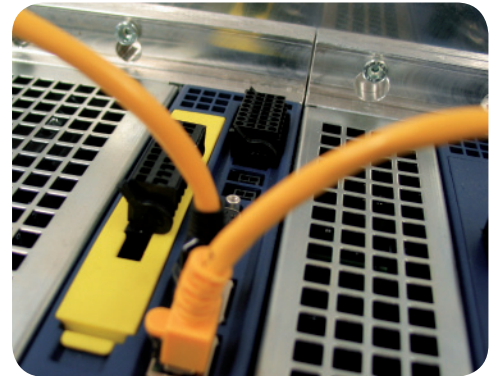

- Safety functions according to IEC 61800-5-2 require a two channel encoder system, i.e. SIL certified SinCos or approved KEB motors with resolver.

A safety fieldbus based on EtherCAT (FSoE) is under development.

## Description:

PL = Performance level

SIL = Safety Integrity Level (IEC 61508)

Module 2 = STO/SBC and two more programable functions, adjustable with the safety programming tool in KEB COMBIVIS 6 / KEB COMBIVIS studio 6

X = fixed function

(x) = parameterizable function

## KEB COMBIVIS 6

KEB COMBIVIS 6 - the new main tool for operation, display, parametrizing and diagnostics. It's a new system with a ".net" based architecture with a lot of available features and ready for future extensions.

Drive settings, application orientated parameter selection in work lists, analysis of the load and motion profiles or signal analysis- with the 16 channel oscilloscope - all in one tool.

Free software download under [www.keb.de](http://www.keb.de) or on the DVD with complete documentation for a service fee under part number CD.SW.010-0100.



## KEB COMBIVIS studio 6

offers a combination of parameterisation and programming of the drive and control technology designed by KEB. Based on the 3S-CoDeSys V3, the KEB COMBIVIS studio 6 incorporates an innovative and future oriented engineering platform, performing standard PLC tasks as well as operating highly dynamic Motion and CNC applications.

Furthermore, the program supports the bus configuration (EtherCAT, CAN, etc.) and contains useful add-ons, e.g. the wizards for motor configurator or for pre-setting of servo motors.

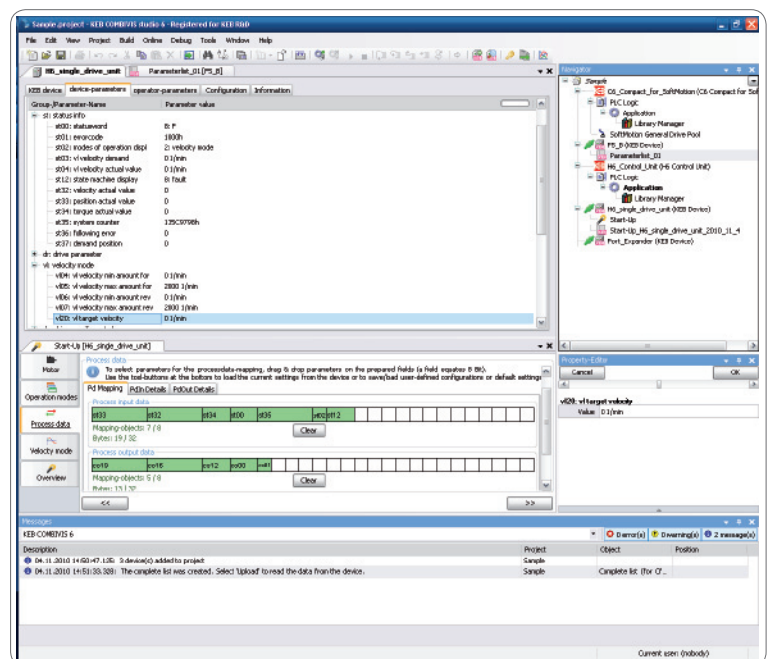

Remote I/O system

The stackable input and output modules of the KEB Remote I/O system transfer the external process signals via the EtherCAT network to the control system integrated into the KEB COMBIVERT H6 or a host control system. The IP 20 highly integrated analog and digital moduls are equipped with pluggable terminal strips. The rugged housings are reinforced with aluminium frames for direct shielding on the terminal.



shielding plates 2 x 8 mm  
part number 00.C6.CD1-0400



shielding plates 1 x 14 mm  
part number 00.C6.CD1-0500

<b>Bus coupler</b>	part number
EtherCAT bus coupler	00.C6.CA1-0100
<b>Digital I/O's</b>	part number
EtherCAT DI 16 (1ms)	00.C6.CB1-0100
EtherCAT DI 32 (1ms)	00.C6.CB1-0200
EtherCAT DO 16 (500mA)	00.C6.CB1-0500
EtherCAT DI 16 / DO 16	00.C6.CB1-0600
<b>Fast counter input</b>	part number
counter, 2 channel	00.C6.CB1-0800
<b>Profibus communication</b>	part number
Profibus slave	00.C6.CH1-0100
<b>Extender unit</b>	part number
2 port module	00.C6.CF1-0100
<b>Analog I/O's</b>	part number
EtherCAT AI 4 (0-20/4-20mA/12bit)	00.C6.CC1-0100
EtherCAT AI 8 (0-20/4-20mA/12bit)	00.C6.CC1-0200
EtherCAT AI 4/8 (0-10/+ -10V/13bit)	00.C6.CC1-0300
EtherCAT AI 8/16(0-10/+ -10V/13bit)	00.C6.CC1-0400
EtherCAT AO 4 (0-20mA/0-10V/12bit)	00.C6.CC1-0500
EtherCAT AI 4 (PT/Ni-100/16bit)	00.C6.CC1-0700
EtherCAT AI 8 (PT/Ni-100/16bit)	00.C6.CC1-0800
EtherCAT AI 4 (PT/Ni-1000/16bit)	00.C6.CC1-0900
EtherCAT AI 8 (PT/Ni-1000/16bit)	00.C6.CC1-1000
EtherCAT AI 4 (Thermo/16bit)	00.C6.CC1-1100
EtherCAT AI 8 (Thermo/16bit)	00.C6.CC1-1200
<b>Shield connection</b>	part number
earth connection 2x8 mm	00.C6.CD1-0400
earth connection 14 mm	00.C6.CD1-0500

## System solutions

The embedded control provides a powerful and cost efficient platform for many automation tasks in machines and systems without an operating system, where all the controller performance is “free” for fast EtherCAT communication and operation of drive axis and/ or peripheral I/O’s.

The operator interface is supported by a wide range of HMI terminal solutions with touch screen panels.

### KEB COMBIVIS studio HMI

The engineering software offers powerful graphic libraries, drag&drop handling and state-of-the-art HMI design features. The three level software licence structure - with BASIC and ADVANCED for the operating system Win CE and BASIC, PRO and ADVANCED for the operating system Win 32 serves different function levels.

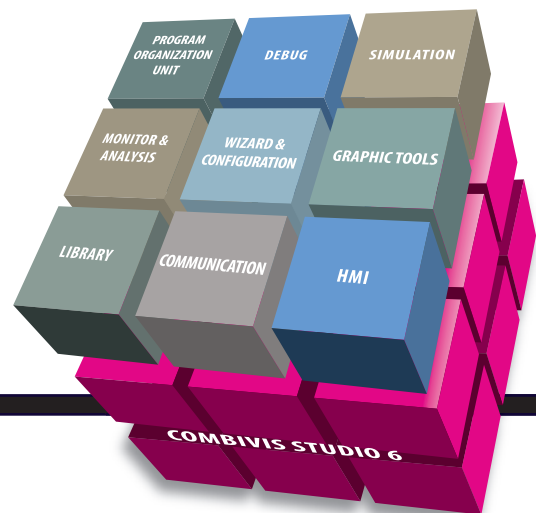

### COMBIVIS connect

The remote control software for the KEB automation solutions erases physical distances, reduce service travel and allows

- remote control of drives and controls
- remote activation
- software modification and updating
- PLC remote debug and automation devices
- preventive and predictive maintenance



KEB COMBICONTROL C6

In addition to the embedded control of the H6 series, we provide a wide range of efficient IPC-based control technology for high level automation and visualisation.

BOX IPC in combination with external monitors for separate installation or combined PANEL IPC with three controller performance levels are available with high resolution touch screen sizes from 6" up to 24" in 4/3 and 16/9 dimension.

Equipped with the Windows XP(e) operating systems, the KEB IPC-based control technology contains an integrated EtherCAT master for the realtime connection with the drive axis and peripheral KEB Remote I/O.

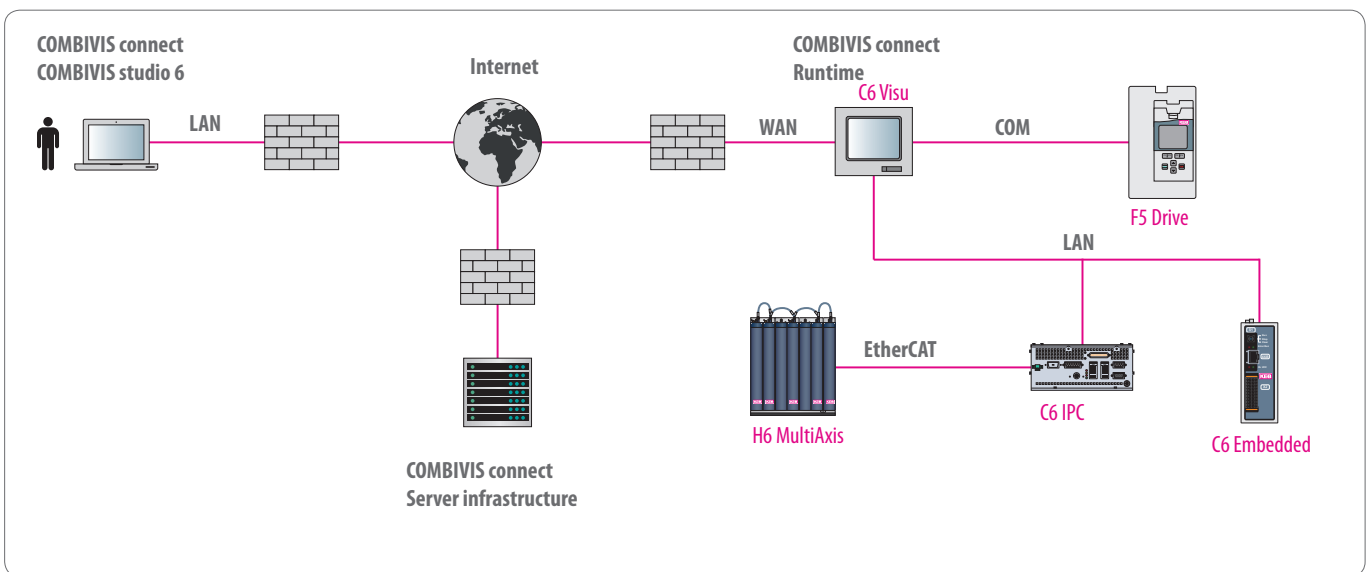

## Servo motors TA series

Synchronous motors transform the electrical specifications into a powerful rotation. The motors are characterised by low inertia and high overload torque and optional also available with permanent magnet brake.

Pluggable terminals for power supply and feedback systems allow variable cable connection for 360°-turns.

The necessity of torque and speed adjustment is often the reason for direct use of gear motors. KEB TA servo motors are assembled in a kit for applications with shaft, hollow shaft, flange or foot mounting and axial or coaxial power flow - all direct connected without extra coupling. High overall efficiency, lifetime lubrication, universal installation positions and robust mechanics are further performance features of the entire series.

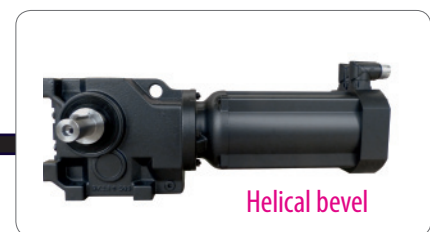
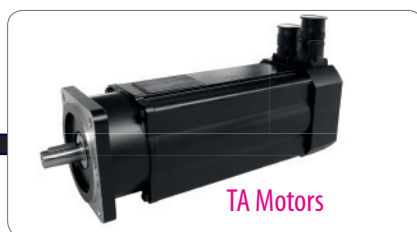

Motor size	rated speed n 10 <sup>3</sup> [rpm]	stall torque T <sub>do</sub> [Nm]	peak torque T <sub>max</sub> [Nm]	inertia J <sub>L</sub> [kgcm <sup>2</sup> ]	motor shaft [mm]	square flange [mm]	helical gears G	shaft mounted gears F	helical worm gears S	helical bevel gears K	planetary P
TA 21	4.5 / 6	0.85	2.55	0.37	11x23	73	■	■	■	■	■
TA 22		1.55	4.65	0.7			■	■	■	■	■
TA 31	2 / 3 / 4.5	1.5	4.5	0.82	14x30	88	■	■	■	■	■
TA 32		2.75	8.25	1.51			■	■	■	■	■
TA 33		3.9	11.7	2.19			■	■	■	■	■
TA 41	2 / 3 / 4.5	6.9	20.7	5.65	19x40	116	■	■	■	■	■
TA 42		9.2	27.6	8.15			■	■	■	■	■
TA 43		11.7	35.1	10.65			■	■	■	■	■
TA 51	2 / 3 / 4.5	11.5	34.5	14.9	24x50	145	■	■	■	■	■
TA 52		16.1	48.3	21.53			■	■	■	■	■
TA 53		20	60	28.15			■	■	■	■	■
TA 61	1.5 / 2 / 3	34.5	103.5	77.71	32x58	190	■	■	■	■	-
TA 62		50	150	113.71			■	■	■	■	-
TA 63		64	192	149.7			■	■	■	■	-
TA 63F		90		■			■	■	■	-	

Stall and peak current depending on rated speed - for details see KEB-DRIVE configuration software

Prefabricated cables for TA servo motors up to 50 m lengths are  
and

resolver encoder cable 00.H6.L50-00xx  
motor cable 1.5 mm<sup>2</sup> 00.S4.019-00xx

## Servo motors DYNAMIC LINE II

Designed for extremely high dynamic the low inertia series is equipped with digital BISS multiturn encoder for absolute position detection and innovative Y-Tec connectors for feedback and power supply with simplified cable connection.

The prefabricated cables up to 50 m lengths for BISS encoder cable 00.H6.L41/L51-00xx and motor cable 1.5mm<sup>2</sup> 00.H6.L00/L10-00xx

and the electronic name plate enable shortest startup times. At the same time, the complete solution reduces possible errors during the installation and ensures high availability and the best serviceability.

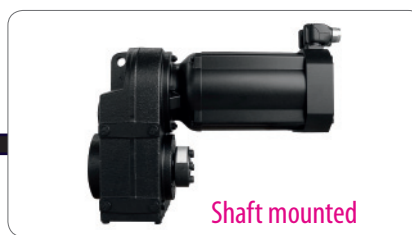
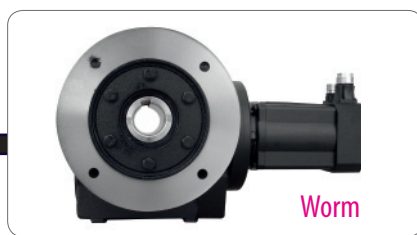

Motor size	rated speed n 10 <sup>3</sup> [rpm]	stall torque T <sub>do</sub> [Nm]	stall current I <sub>do</sub> [A]	peak torque T <sub>max</sub> [Nm]	peak current I <sub>max</sub> [A]	inertia J <sub>L</sub> [kgcm <sup>2</sup> ]	motor shaft [mm]	square flange [mm]
A1	6	0.47	0.94	2.1	4.5	0.13	9 x 20	55
A2		0.66	1.24	2.9	5.6	0.18		
A3		0.87	1.43	3.8	6.9	0.23		
A4		1.14	1.55	5.0	8.0	0.34		
B1	3/4/6	0.92	1.2	2.7	4.5	0.33	14 x 30	90
B2		1.8	2.0	5.4	7.7	0.56		
B3		2.6	2.7	7.8	10.8	0.79		
C1	2/3/4	3.9	3.1	12	10.5	2.7	19 x 40	102
C2		5.7	5.0	17.5	16.8	3.7		
C3		7.1	7.0	22	20	4.7		
C4		8.5	8.5	26	23.8	6.0		
D1	1.5/2/3	8.2	6.0	25	20.1	7.9	24 x 50	140
D2		11.6	8.9	36	30.1	11.2		
D3		15.3	11.2	47	37.7	14.4		
D4		18.4	14	57	47.4	19.5		
E1	1/2/3	21.4	11.8	65	39.3	57	32 x 58	195
E2		35.1	19.6	106	64.1	79		
E3		49.7	27.7	150	90.4	102		

# Headquarters

## Karl E. Brinkmann GmbH

Försterweg 36 - 38 • D - 32683 Barntrup  
Fon +49 5263 401-0 • Fax 401-116  
Internet: [www.keb.de](http://www.keb.de) • E-Mail: [info@keb.de](mailto:info@keb.de)



KEB Antriebstechnik GmbH • Getriebemotorenwerk  
Wildbacher Straße 5 • D - 08289 Schneeberg

Fon +49 3772 67-0 • Fax 67-281

Internet: [www.keb-drive.de](http://www.keb-drive.de) • E-Mail: [info@keb-drive.de](mailto:info@keb-drive.de)



## COMPANIES

### AUSTRIA

KEB Antriebstechnik  
Austria GmbH  
Ritzstraße 8  
A - 4614 Marchtrenk  
Tel: +43 (0)7243 53586-0  
Fax: +43 (0)7243 53586-21  
E-mail: [info@keb.at](mailto:info@keb.at)  
Internet: [www.keb.at](http://www.keb.at)

### CHINA

KEB Power Transmission  
Technology (Shanghai) Co. Ltd.  
No. 435 QianPu Road  
Songjiang East Industrial Zone  
CN-201611 Shanghai, P.R. China  
Tel: +86 (0)21 37746688  
Fax: +86 (0)21 37746600  
E-mail: [info@keb.cn](mailto:info@keb.cn)  
Internet: [www.keb.cn](http://www.keb.cn)

### FRANCE

Société Française KEB  
Z.I. de la Croix St. Nicolas  
14, rue Gustave Eiffel  
F - 94510 LA QUEUE EN BRIE  
Tel: +33 (0)149620101  
Fax: +33 (0)145767495  
E-mail: [info@keb.fr](mailto:info@keb.fr)  
Internet: [www.keb.fr](http://www.keb.fr)

### GREAT BRITAIN

KEB (UK) Ltd.  
6 Chieftain Business Park,  
Morris Close  
Park Farm, Wellingborough  
GB - Northants, NN8 6 XF  
Tel: +44 (0)1933 402220  
Fax: +44 (0)1933 400724  
E-mail: [info@keb-uk.co.uk](mailto:info@keb-uk.co.uk)  
Internet: [www.keb-uk.co.uk](http://www.keb-uk.co.uk)

### ITALY

KEB Italia S.r.l. Unipersonale  
Via Newton, 2  
I - 20019 Settimo Milanese (Milano)  
Tel: +39 02 3353531  
Fax: +39 02 33500790  
E-mail: [info@keb.it](mailto:info@keb.it)  
Internet: [www.keb.it](http://www.keb.it)

### JAPAN

KEB - Japan Ltd.  
15 - 16, 2 - Chome  
Takanawa Minato-ku  
J - Tokyo 108 - 0074  
Tel: +81 (0)33 445-8515  
Fax: +81 (0)33 445-8215  
E-mail: [info@keb.jp](mailto:info@keb.jp)  
Internet: [www.keb.jp](http://www.keb.jp)

### RUSSIA

KEB CIS ZAO  
Lesnaya str, house 30  
Dzerzhinsky (MO)  
RUS - 140091 Moscow region  
Tel: +7 (0)495 5508367  
Fax: +7 (0)495 6320217  
E-Mail: [info@keb.ru](mailto:info@keb.ru)  
Internet: [www.keb.ru](http://www.keb.ru)

### USA

KEB America, Inc  
5100 Valley Industrial Blvd. South  
USA - Shakopee, MN 55379  
Tel: +1 952 2241400  
Fax: +1 952 2241499  
E-mail: [info@kebameric.com](mailto:info@kebameric.com)  
Internet: [www.kebameric.com](http://www.kebameric.com)

### Representative offices

- Belgium
- Brazil
- Korea
- Sweden
- Spain

Further partners for ...

Australia • Belgium • Bulgaria • Czech Republic • Denmark • Egypt • Greece • Hungary • India • Indonesia • Iran • Israel • Malaysia • Morocco • Netherlands • New Zealand • Pakistan • Poland • Portugal • Romania • Singapore • Slovakia • South Africa • Spain • Sweden • Switzerland • Taiwan • Thailand • Tunisia • Turkey • Uzbekistan

... under [www.keb.de/en/contact/keb-worldwide.html](http://www.keb.de/en/contact/keb-worldwide.html)



© KEB 00.00.000-52H6 / 02-2013 • Subject to technical alterations!

